

Soffitto combustibile  
(Tutti i modelli)

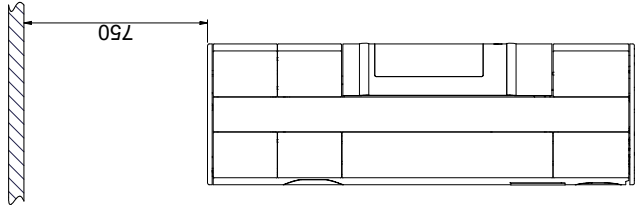

Scan 83-5 e Scan 83-6

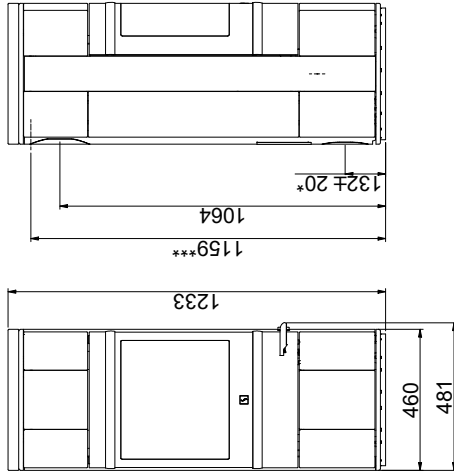

Scan 83-7 e Scan 83-8

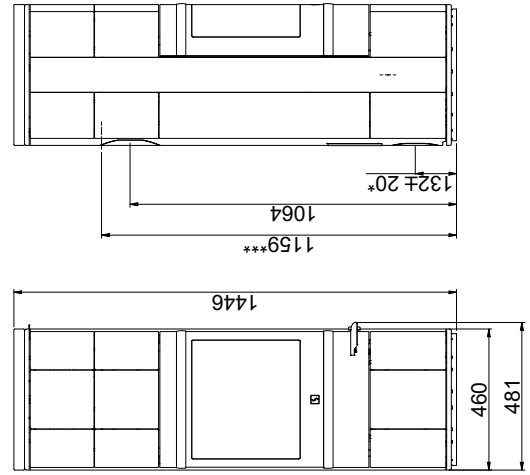

Scan 83-1 e Scan 83-2

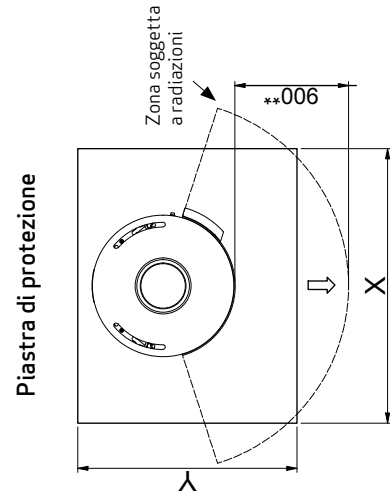
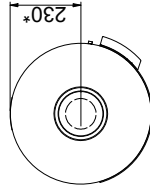
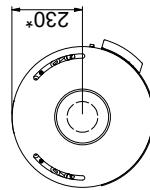
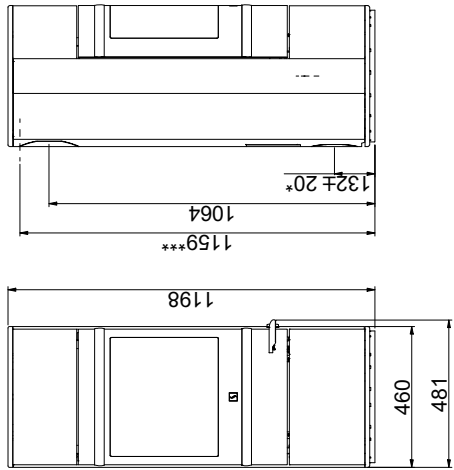

X/Y = In conformità alle leggi e alle normative nazionali



Sono tutte distanze minime  
Tutte le distanze sono distanze minime  
\* Presa d'aria esterna Ø 100 mm  
\*\* Distanza minima per i mobili/materiale infiammabile  
\*\*\* Altezza fino all'inizio del raccordo fumi sullo scarico superiore