

Soffitto combustibile

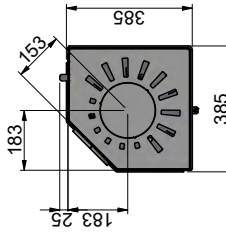

Scan 80-3 e Scan 80-4

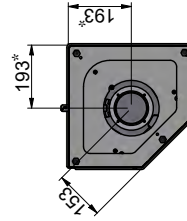
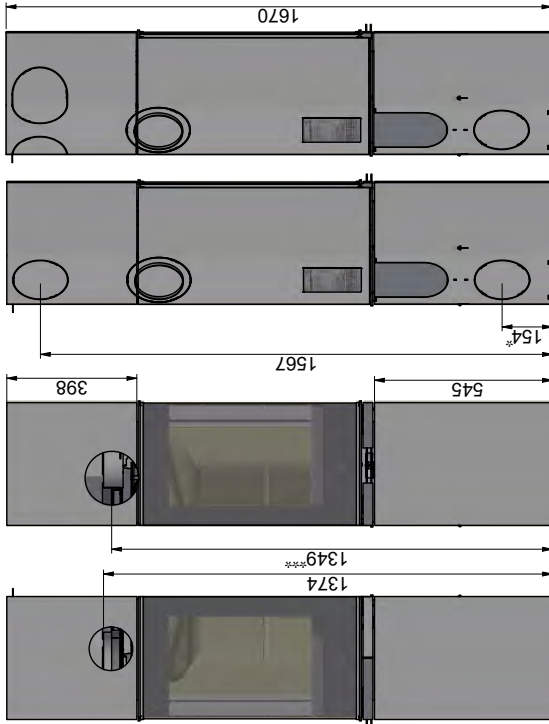

Scan 80-1 e Scan 80-2

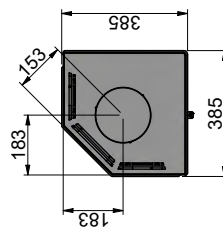
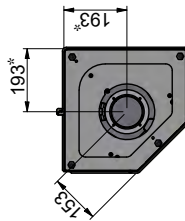
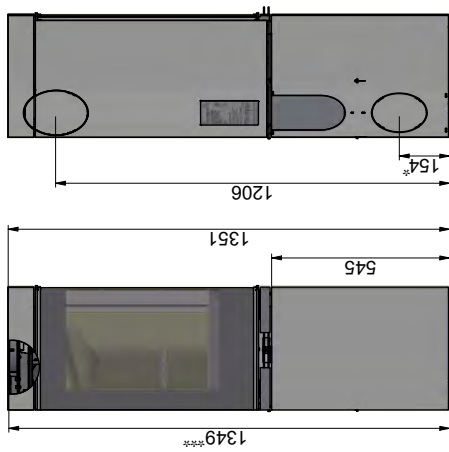

Sono tutte distanze minime
 Tutte le distanze sono distanze minime
 * Presa d'aria esterna Ø 100 mm
 ** Distanza minima per i mobili/materiale infiammabile
 *** Altezza fino all'inizio del raccordo fumi sullo scarico superiore

Piastra di protezione

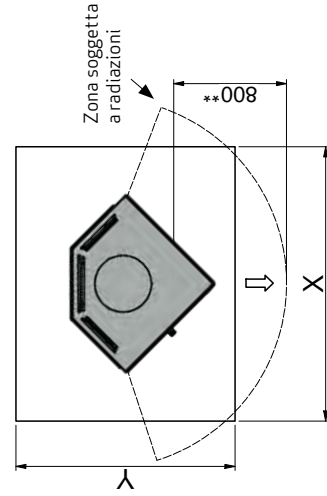

X/Y = In conformità alle leggi e alle normative nazionali