

Pavimento combustibili

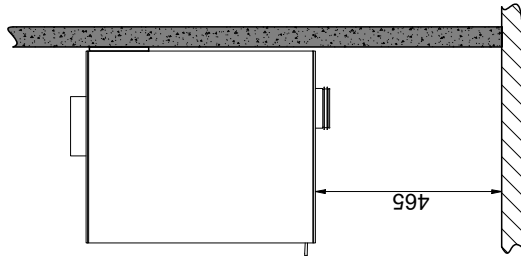

Scan 1003-B con zoccolo

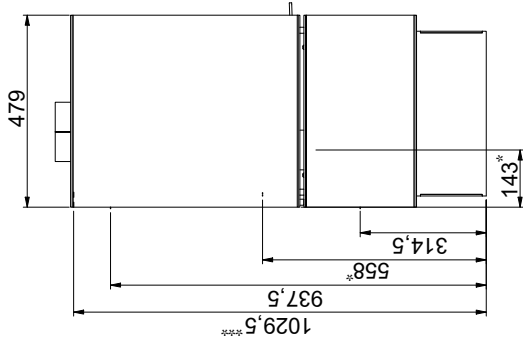

Scan 1003-B

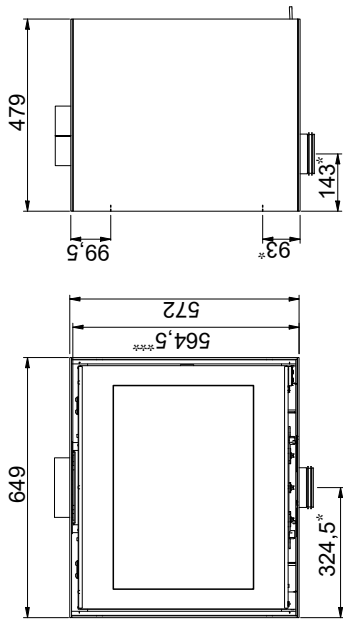

Scan 1003-B

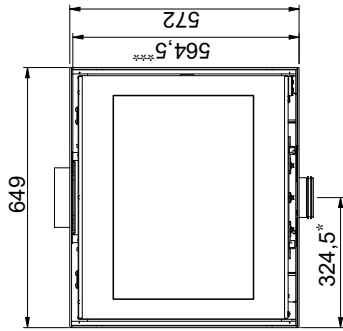

Scan 1003-B

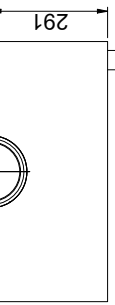
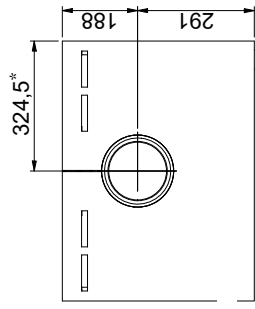
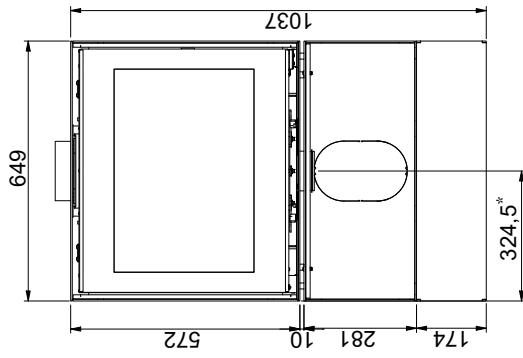

Piastra di protezione

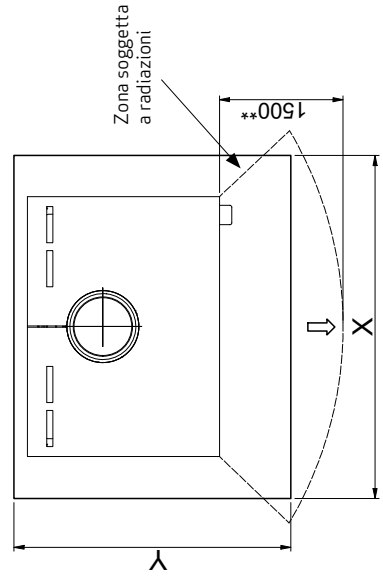

X/Y = In conformità alle leggi e alle normative nazionali



Materiale incombustibile



Fire wall, e.g. 50 mm Jøtul Firewall, 110 mm di mattoni o altro materiale con resistenza al fuoco simile e capacità di isolamento

Sono tutte distanze minime

Tutte le distanze sono distanze minime

\* Presa d'aria esterna Ø 100 mm

\*\* Distanza minima per i mobili/materiale incombustibile

\*\*\* Altezza fino all'inizio del raccordo fumi sullo scarico superiore